



40402 36" x 24" CABINET BLASTER
40403 36" x 24" CABINET BLASTER WITH FOOT PEDAL

INSTRUCTION AND ASSEMBLY MANUAL



PLEASE READ INSTRUCTIONS
COMPLETELY BEFORE STARTING
ANY ASSEMBLY



DIVISION OF S&H INDUSTRIES
5200 Richmond Road • Cleveland, OH 44146
Phone 216-831-0550 • Toll Free 800-253-9726 •
Fax 216-831-9573
www.shindustries.com
E-mail: www.service@shindustries.com

WARNING!

Do not use an ALC Cabinet Blaster until you have read this manual and you understand its contents and warnings. These warnings are included for the health and safety of the operator and those in the immediate vicinity. Keep this manual for future reference.

Dust created by power sanding, sawing, grinding, drilling, and other construction activities may contain chemicals known to cause cancer, birth defects or other reproductive harm and respiratory illnesses. Some examples of the chemicals include:

- Lead from lead based paints
- Crystalline silica from bricks, cement and other masonry products
- Arsenic and chromium from chemically-treated lumber

Your risk from these exposures varies, depending on how often you do this type of work. To reduce your exposure to these chemicals: Work in a ventilated area, and work with approved safety equipment, such as those dust masks that are specially designed to filter out microscopic particles.

Abrasive blasting produces harmful dust. Everyone in the blasting area must wear a properly fitted and properly maintained NIOSH approved air supplied respirator.

SILICOSIS AND OTHER DUST WARNINGS:

Breathing dust from silica sand may cause silicosis, a fatal lung disease. Breathing dust during blasting operations may also cause asbestosis and/or other serious or fatal diseases. A NIOSH-approved, well maintained air supplied abrasive blasting respirator must be used by anyone blasting, anyone handling or using media containing toxic substances or media with more than point one percent (.001) free crystalline silica and anyone in the area of the dust. Harmful dust can remain suspended in the air for long periods of time after blasting has ceased, causing serious injury or death.

Before removing respirator, use an air monitoring instrument to determine if atmosphere is safe to breathe. Contact local OSHA or NIOSH office to determine the proper respirator for your particular application.

Air supplied respirators do not remove or protect against carbon monoxide (CO) or any other toxic gas. Use a carbon monoxide removal device and monitoring device with the respirator to ensure grade D quality air. Follow all applicable OSHA standards and OSHA regulation 1910.134 (d).

CABINET OPERATION

1. Assemble light and siphon gun/foot pedal per instructions.
2. Attach gloves to inner glove hole collar and secure with glove clamps included in parts kit.
3. Remove dust collector hose from bottom of drum and connect one end to the dust collector and the other end to the right upper side of cabinet.
4. Plug light and dust collector electric cords into your 110 volt, 60 cycle electric line.
5. Pour 25 – 50 pounds of dry abrasive blasting material into cabinet through door opening.
6. Attach air line to air inlet (if you have a trigger gun) or foot pedal valve marked “IN” (if you have the foot pedal option).
7. Most blasting operations will be performed between 60 and 100 PSI. Regulate pressure at compressor as necessary. Maximum 110 PSI.

WARNING AND SAFETY INFORMATION

Do not operate cabinet or air flow with cabinet door open or with cabinet lens removed.

Do not use fluids or mix fluids with blast media.
This cabinet is designed for dry blasting only.

Do not exceed maximum operating pressure of 110 PSI.

WARNING!

Disconnecting hose while Unit is under pressure could cause serious injury or death. Use safety lock pins and safety cables in all coupling connections to help prevent hose couplings from accidental disconnection.

If twist-on type air hose couplings are used, they must be secured by safety lock pins or wires to prevent accidental disconnection while under pressure. Hose disconnection while under pressure could cause serious injury.

CABINET BLASTER SAFETY PROCEDURES

CAUTION: READ THESE SAFETY PROCEDURES IN THEIR ENTIRETY – PARTS OF THE OPERATING INSTRUCTIONS ARE WITHIN THESE WARNINGS.

These procedures are not intended to be exhaustive due to the many variables in the abrasive blasting field. Therefore, we **INSIST** that the hands, ears, mouth, nose and eyes be covered with appropriate safety protection at all times.

ADDITIONAL WARNINGS! CAUTION MUST BE EXERCISED BY USER AT ALL TIMES

- 1. Do not exceed maximum working pressure of 110 PSI. Failure to keep maximum working pressure below 110 PSI can cause the blast machine to burst, causing death or serious injury.**
- 2. Everyone in the blast area including the equipment operator should correctly use and maintain a NIOSH approved air supplied respirator, even after blasting has ceased. Harmful dust can remain suspended in the air for long periods of time after blasting has ceased causing injury or death**
- 3. Before using the pressure blaster: Put on safety glasses, gloves, and NIOSH approved respirator. Always wear these protective items when operating and while servicing your abrasive blaster. A well maintained air supplied blasting respirator must be used by anyone blasting.**
- 4. For safe operation, perform recommended preventive maintenance on blaster cabinet, and accessories. Replace all worn parts before they fail. Immediate replacement of worn components is required. Failure to replace worn components could result in exposing the operator or bystanders to high speed media and compressed air, causing serious injury.**
- 5. Do not use corrosive materials of any type in unit. Use only clean, dry media.**
- 6. Static electricity can be created by the use of this equipment. Do not use within fifty feet of any explosive, potentially explosive substances, or their vapors as an explosion can occur.**

7. **Do not use this equipment in any area that might be considered hazardous or where flammable gases or liquids are present. Failure to do so may cause an explosion resulting in serious injury.**

AIR COMPRESSOR RECOMMENDATION:

To permit efficient operation of your air compressor, follow these guidelines:

1. Use a smaller size nozzle and air jet to control the demand of air.
2. Do not blast continuously. Stop blasting operation periodically to allow the compressor to cool. No compressor is designed to constantly run at full RPM. Use 70% of the rated output.
3. Use a minimum 1/2" air hose or metal piping from your air compressor to the blaster. If your compressor is creating an excessive amount of moisture, we recommend using a water trap or a moisture separator.
4. The air compressor should be drained at the bottom of the supply tank through a drain valve and should be blown down daily. It is not unusual to drain three or four gallons of water from the supply tank on a high humidity day. An additional supply tank will help.
5. Keep dust and media created by blasting away from the air compressor unit. Observe maximum air pressure requirements for the blaster and either set your compressor to run within these limits or use a pressure regulator valve to reduce the air pressure to the appropriate range.

ABRASIVE (MEDIA) USAGE:

1. If moisture is in the media it will eventually damage the blaster tank or plug the system. Keep the media and compressor air dry to avoid this problem.
2. If media is moist, screen it and dry it before using.
3. Do not leave media in the tank after blasting because it can absorb moisture and impair blasting performance.
4. Store media in a dry place; keep media off the ground or concrete floors. Put it on a wooden skid.
5. If the humidity is excessively high, it may not be advisable to blast at that time.
6. Consider using different grades or different types of media to prevent nozzle clogging due to high moisture content.
7. Do not use sand.

MAINTENANCE

Check siphon gun nozzle and air jet for wear when replacing. Proper matching of nozzle and air jet is very important for effective blasting. Match size or color small/small (gold), medium/medium (silver) and large/large (black). Replace media when worn or excessive dusting occurs. Check and clean dust collector and filter frequently.

WARNING!

The threads on the nozzle holder and set screws must be inspected each time the nozzle is secured to the holder. Check the threads for wear, and make sure nozzle set screw securely grips the nozzle. The nozzle washer must also be inspected for wear. Worn nozzle washers cause erosion. A loose-fitting nozzle may eject from the holder under pressure and could cause severe injury.

WARNING!

Failure to observe the following before performing any maintenance could cause serious injury or death from the sudden release of compressed air:

- Disconnect power supply.
- Lockout and tagout the compressed air supply.
- Bleed the air supply line to the blast gun.

Immediate replacement of worn components is required. Failure to replace worn components could expose the operator or bystanders to high speed media and compressed air could cause death or serious injury.

Leaks around couplings and nozzle holders indicate worn or loose fitting parts. Nozzle holders and couplings that do not fit tightly on hose and nozzles that do not fit tightly in nozzle holders could disconnect while under pressure. Impact from nozzles, couplings, hoses, or abrasive, and parts disconnected while under pressure could cause severe injury.

LIGHT ASSEMBLY INSTRUCTIONS

Before assembly check to see that all components have been received with cabinet.

Part No.	Qty.	Description	Part No.	Qty.	Description
11007	1	Light fixture	11012	1	Power cord connector
11008	1	Power cord	11014	1	3/4" Sheet Metal Plug
11009	1	Switch	11013	1	Wire nut
11010	1	Electrical box	11160	2	8-32 x 1/2" machine screw
11011	1	Box cover	11161	4	8-32 hex nut

NOTE: Gasket and 8-32 x 1" machine screws are in light assembly.

Follow all electrical and safety codes, as well as the National Electric Code (NEC) and OSHA regulations.

Please read and follow instructions in sequence for proper installation. Refer to schematic for help in installation.

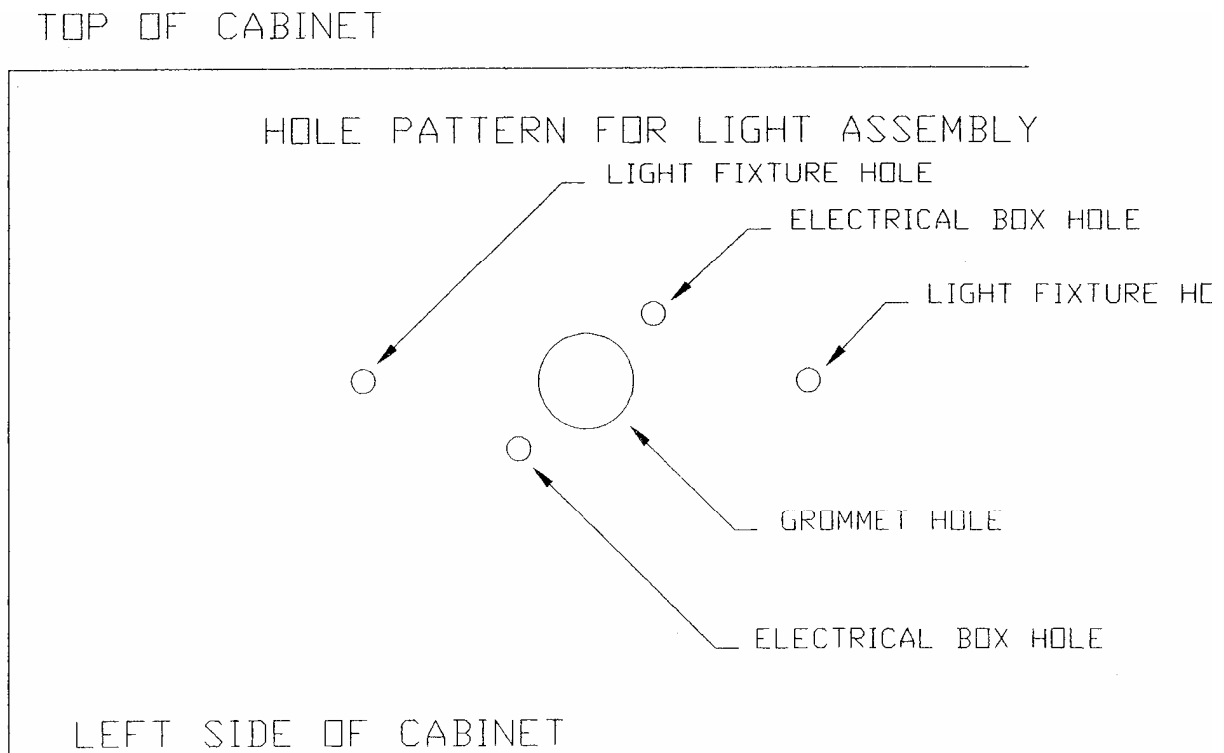

LIGHT ASSEMBLY INSTRUCTIONS

1. Press metal plug into 3/4" diameter hole from inside of cabinet. (The purpose of the grommet is to prevent abrasion of the light wires.)
2. Install electrical box to outside of cabinet using two 8-32 x 1/2" machine screws and two 8-32 hex nuts. Holes in box and cabinet are prepunched. NOTE: Use one of the machine screws to secure ground wire (green wire) to back of box. Power cord is secured to box and should face down when box is properly attached.
3. Route wires from light base through gasket and center of grommet into electrical box. Install light with gasket between cabinet wall and light base using two 8-32 x 1" machine screws and two 8-32 hex nuts.
4. Secure white wire from light and white wire from power cord with wire nut and leave in box.
5. The electrical switch has two screws on the side of the switch. Attach black lead from light to one screw and black lead from power cord to other screw. Attach switch to box and install box cover to switch.
6. Before installing bulb and plugging in power cord, it is recommended that all connections be checked and light fixture hot, neutral and ground connections be checked using appropriate testing meters.
7. Install light bulb (not included) maximum 60 watt.

ASSEMBLY DIAGRAM FOR BLAST CABINET

Below is the component breakdown for ALC Cabinet Blasters. Please see separate instructions and parts breakdowns for light assembly, siphon gun/foot pedal and dust collector.

Item No.	Part No.	Description	Item No.	Part No.	Description
1	11635	Window frame	6	11161	8-32 hex nut
2	40251	Window lens	7	40248	Gloves – 1 pair
3	40253	Window lens underlayment	7	40240	Glove clamp – 1 pair
4	11601	1/2" x 1" sealing foam (per foot)	8	10904	Drain plug
5	10199	1/4-20 x 1" machine screw	9	11574	Grommet for dust collector hose
5	10201	1/4-20 hex nut	10	11589	Side door
5	10218	1/4" USS washer	11	11610	Handle for side door
6	11109	Hasp	11	11611	CAM for side door handle
6	11160	8-32 x 1/2" machine screw			

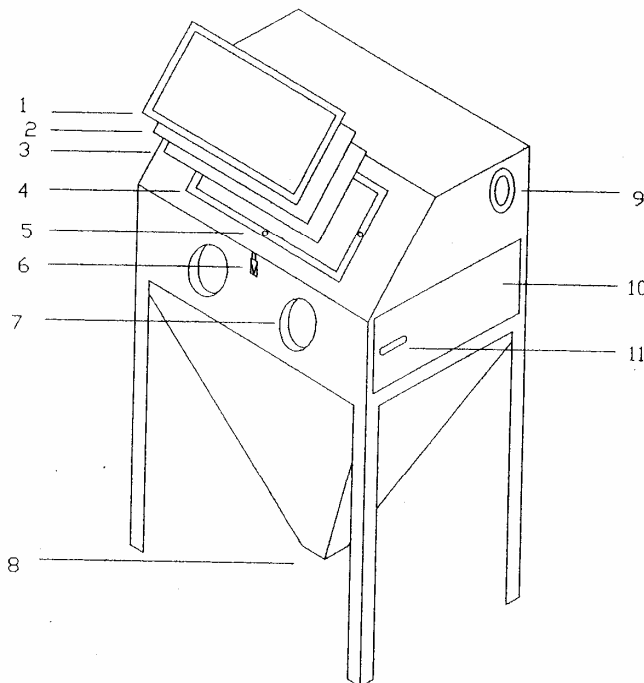

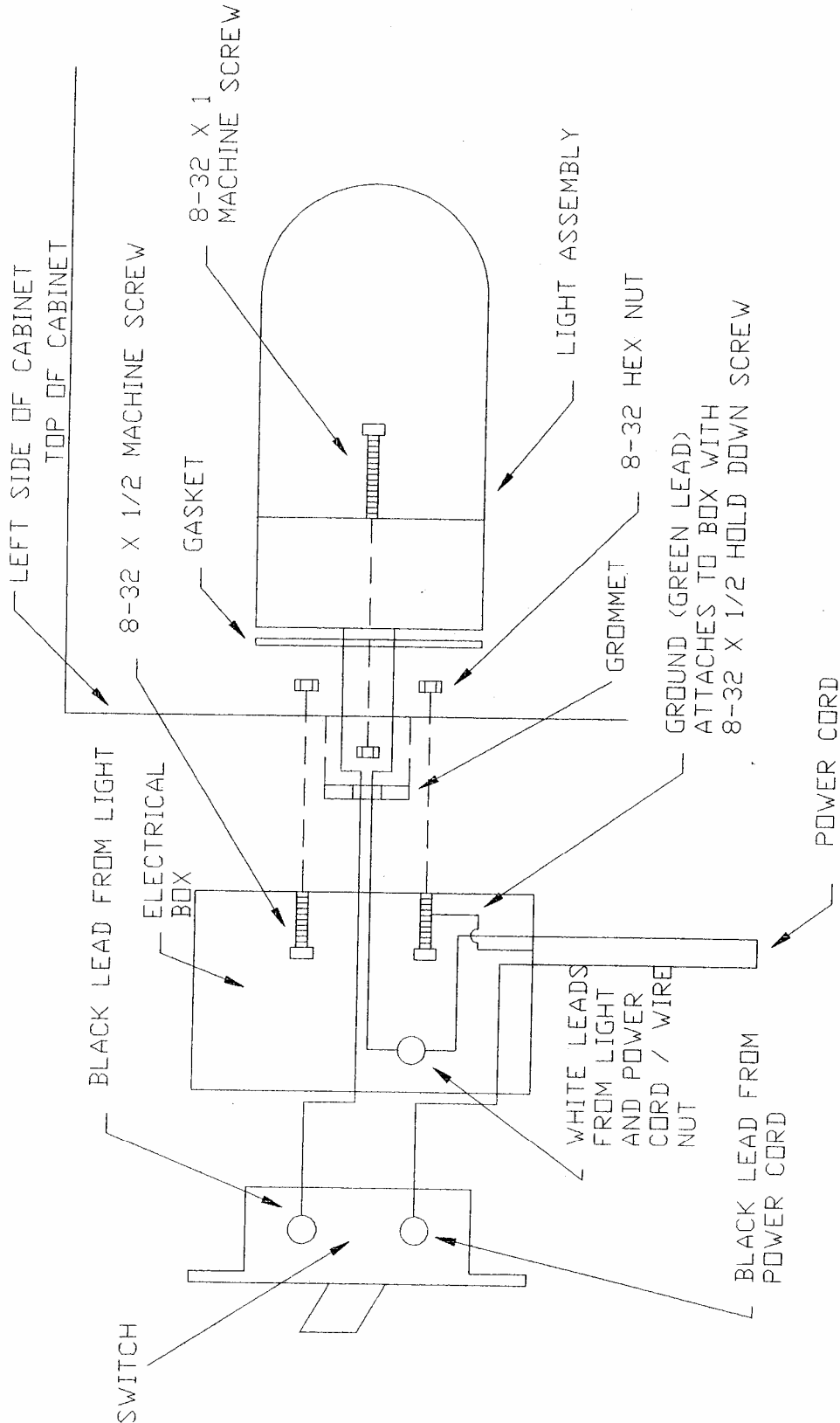

Use maximum 60 watt bulb (not included)

OPTIONAL SIPHON GUN/FOOT PEDAL ASSEMBLY INSTRUCTIONS

Below is the component breakdown for siphon gun/foot pedal.

Part No.	Description
11595	Siphon gun pressure hose (6')
11596	Foot pedal pressure hose (8')
11594	Foot pedal assembly
11632	Foot pedal valve
11606	1/4" pipe coupling (air pressure inlet)
10188	1/2" washer (pressure hose to pipe coupling washer)
11579	Siphon tube (pickup tube)
11597	Siphon hose (5/8" ID) – 8'

NOTE: See separate sheet for siphon gun parts breakdown.

1. Put end of 6' pressure hose through 1/2" washer and insert through air inlet hole from inside of cabinet. Install 1/4" pipe coupler to end of pressure hose from outside of cabinet and tighten.
2. Install siphon gun to opposite end of 6' pressure hose and tighten securely.
3. Shop air installs to 1/4" pipe coupling.
4. If installing foot pedal option, install 8' pressure hose to pipe coupling from outside and install other end of pressure hose to foot pedal valve marked "OUT". Shop air installs to foot pedal valve marked "IN". Foot pedal valve fitting marked "EXHAUST" must be kept open at all times.
5. Install siphon hose to siphon gun and opposite end to siphon tube at right front of cabinet. Opposite end of siphon tube

must be kept open and clear of any debris for proper operation.

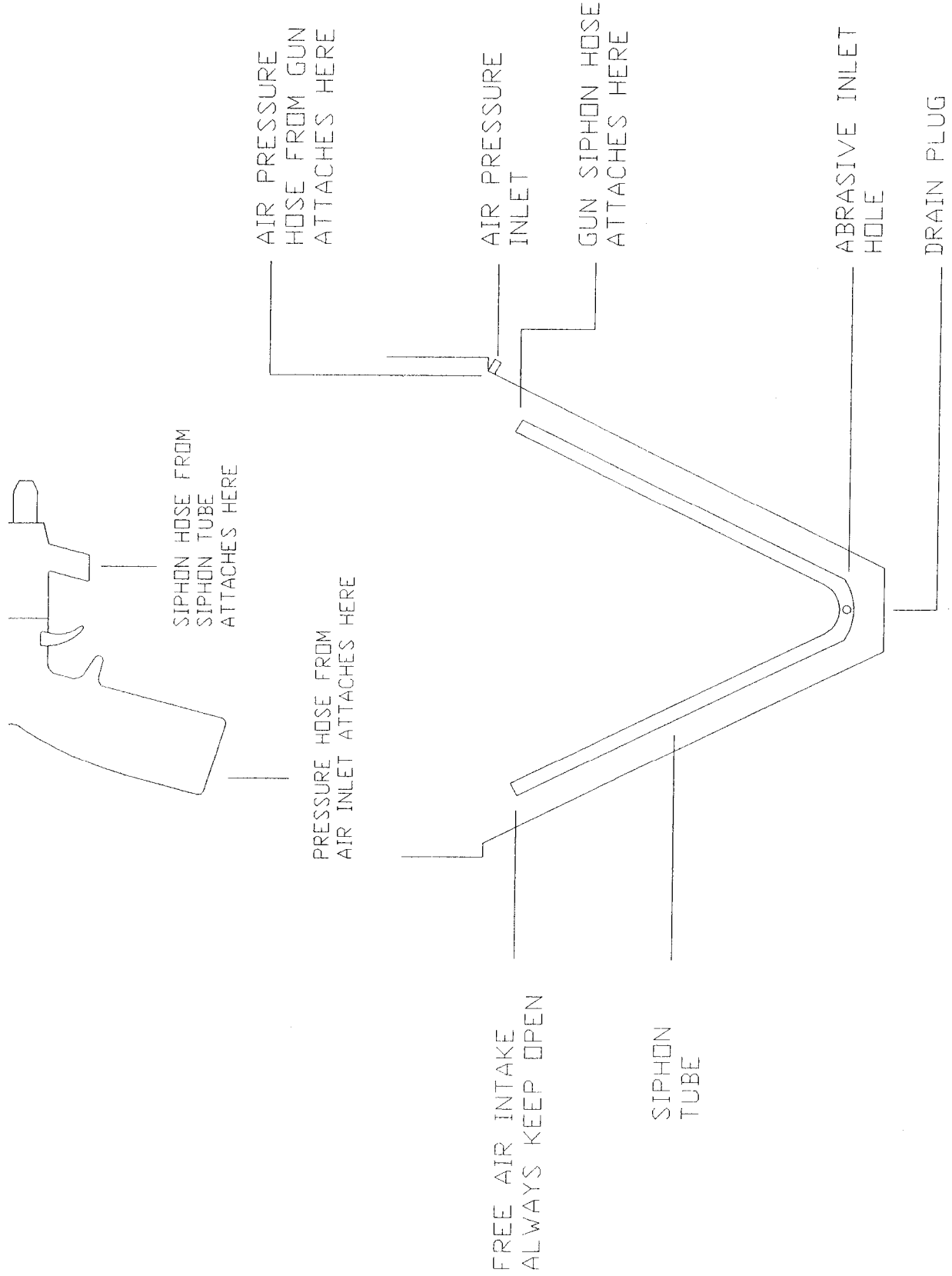

SIPHON GUN PARTS BREAKDOWN Replacement Parts and Optional Accessories

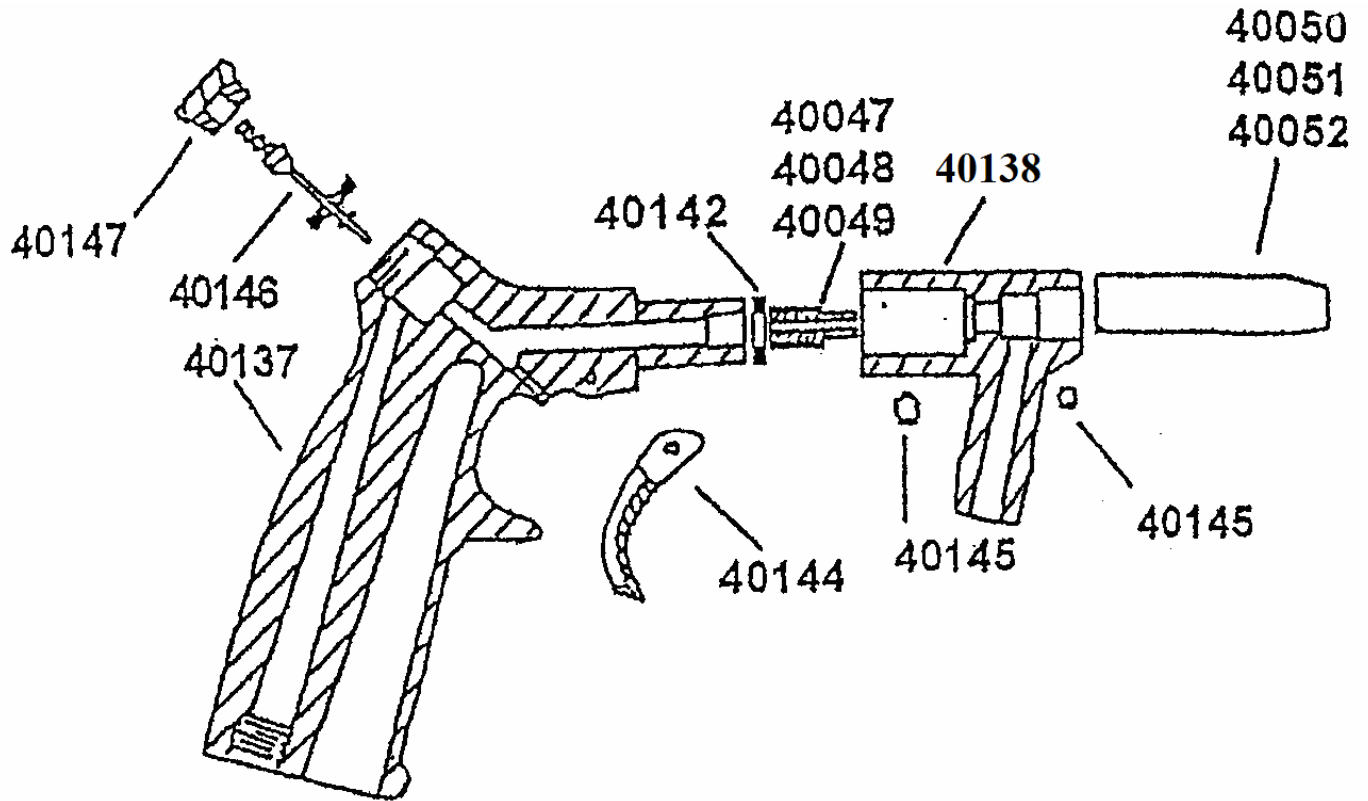

REPLACEMENT PARTS	
PART NO.	DESCRIPTION
11665	Blast gun for foot pedal
40153	Blast gun for trigger operation
40137	Blast gun handle only, with trigger and valve
11664	Blast gun handle only, for foot pedal
40138	Blast gun siphon head only, with nozzle and air jet
40142	Washer
40144	Blast gun trigger
40145	Blast gun set screw
40146	Blast gun valve, spring and seat assembly
40147	Valve nut
40050	13/64" - steel nozzle (optional)
40051	1/4" steel nozzle (included)
40052	5/16" steel nozzle (optional)
40047	5/64" air jet (gold) (optional)
40048	1/8" air jet (silver) (included)
40049	5/32" air jet (black) (optional)

ASSEMBLY DIAGRAM FOR DUST COLLECTOR

Below is the component breakdown for ALC 100 CFM dust collector. The dust collector is assembled and ready for use. Dust collector hose is located in the bottom drum of the collector and must be removed and attached to dust collector and cabinet.

Item No.	Part No.	Description	Item No.	Part No.	Description
1	11568	Cap for dust collector	6	11567	Motor screen
1	10759	Protective edging	7	40287	Vacuum motor
2	11637	Switch	8	11602	Motor support bracket
3	11012	Connector	9	11564P	Top drum
3	11008	Electric cord	10		N/A
4	40267 SM	Filter bag	11	11565P	Bottom drum
5		n/a	12	11575	Dust Collector Hose 2 1/4" x 6"

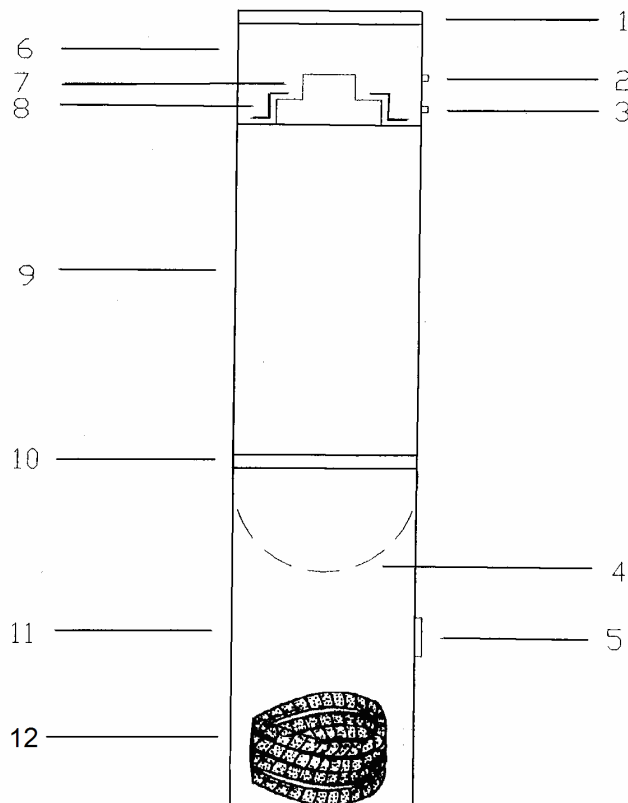

TROUBLESHOOTING TIPS

PROBLEM/CAUSE

POSSIBLE SOLUTION

Surging of blast flow:

Air pressure too low

Check pressure gauge on air compressor

Excessive media consumption:

Air pressure too low

Check pressure gauge on air compressor

Clogging and plugging of blast flow:

Debris in media
Media size too large
Nozzle plugs
Wet media

Purge and screen
Use smaller grit size
Use larger nozzle and correct
Dry media, drain water from air

Moisture in abrasive media:

Wet media
Water in air

Change or use dry media
Drain water from air lines

Humid weather:

Moderate humidity
Moderate humidity
High humidity

Keep media as dry as possible
Use drier or moisture separator
Avoid that period of use if possible

Overtaxed Compressor:

Compressor too small
Nozzle size too large
Too many leaks in plumbing
Holes in abrasive hose
Air filter on compressor plugged

Restrict time used
Use smaller size
Seal and tighten plumbing
Replace hose
Clean or replace filter

Lack of air pressure:

Compressor too small
Supply valves not on full position
Nozzle size too large
Leaks in plumbing
Holes in abrasive hose
Air filter on compressor plugged

Use smaller nozzle
Open valves
Use smaller size
Seal and tighten plumbing
Replace hose
Clean or replace filter

Lack of abrasive flow:

Blaster empty
Moisture in media
Not enough air pressure
Abrasive hose kinked
Debris in media

Fill cabinet
Dry media
Check system
Straighten hose
Clean or screen media

Coal Slag #40093

Coal Slag is used when paint and rust has to be removed from steel, such as car bodies, tanks or heavy machinery. Coal Slag is faster cutting, can be re-used, is moisture free, and will not pack or absorb moisture. (25 Lb. container)

Steel Grit #40109

Steel grit is extremely fast cutting on rusty metal and hard to remove paint. Steel Grit is popular because it leaves a very smooth finish. It is also comparable in price to most other specialty abrasives. Steel Grit is recommended in reclaim systems or cabinets. (25 Lb. container)

Glass Bead #40105

Glass Bead is used in creating a satin or matte finish. Glass Bead is recommended in reclaim systems or cabinets. (25 Lb. container)

Aluminum Oxide #40098

Aluminum Oxide is a high quality abrasive that is sharper than sand (not recommended) and cuts twice as fast as sand. It leaves a smooth textured finish with no pits or burrs. Aluminum Oxide is rougher than glass bead and can be used over and over again. It is one of the most economical abrasives you can use in any reclaim systems or cabinets. (4/25 Lb. container)

Plastic Grit #40110

Primarily used to strip aluminum and fiberglass. Great for stripping paint, light oxidation and surface rust. Recommended for use in blast cabinets because it creates very little dust. Works quickly, last a long time and increases visibility within the cabinet. (10 Lb. container)

Walnut Shells #40112

Walnut shells are recommended for use on "soft" surfaces such as aluminum, glass, wood, and other areas where no pitting is desired. Leaves a smooth, dull finish. (10 Lb. container)

Disclaimer of Warranties. S & H Industries, Inc. ("Seller") makes no warranties with respect to any goods delivered to Buyer or users except as specifically set forth within this manual. S & H INDUSTRIES, INC. MAKES NO IMPLIED WARRANTIES OF MERCHANTABILITY OR FITNESS FOR A PARTICULAR PURPOSE WITH RESPECT TO ANY OF THE GOODS, AND S & H INDUSTRIES, INC. EXPRESSLY DISCLAIMS ANY IMPLIED WARRANTIES AGAINST INFRINGEMENT. S & H INDUSTRIES, INC. WARRANTIES SHALL NOT APPLY TO ANY DAMAGE OR NON-CONFORMITY RESULTING FROM THE NEGLIGENCE OF IMPROPER ASSEMBLY OR USE OF ANY GOODS BY USERS OR BUYER OR ITS EMPLOYEES OR AGENTS, OR FROM ALTERATION OR ATTEMPTED REPAIR BY ANY PERSON OTHER THAN S & H INDUSTRIES, INC. ALL USED, REPAIRED, MODIFIED OR ALTERED ITEMS ARE PURCHASED AS-IS AND WITH ALL FAULTS.

Indemnification Agreement. Buyer agrees, to the fullest extent permitted by the law, to fully indemnify, hold harmless, and defend Seller, its parent, subsidiary, and affiliated companies, its owners, officers, directors, employees, agents, representatives and insurers (collectively, "Indemnities") from and against any and all claims, demands, suits, damages, judgments of sums of money, losses and expenses, including but limited to attorney's fees and costs (collectively "referred to herein as "Claims") arising out of or resulting from any bodily injury, sickness, disease or death or injury to or destruction of tangible property, arising out of or resulting from the use, sale or distribution of any and all products purchased from Seller by Buyer, regardless of whether or not such claim arises in whole or in part out of Seller's alleged fault, including but not limited to Seller's negligence, strict liability, products liability, breach of warranty or any other act or omission. Buyer expressly waives any and all immunity from suit by Seller, its parent, subsidiary, and affiliated companies, and its owners, officers, directors, employees, agents, representatives and insurers, by operation of any workers' compensation law or statute. **By purchasing from S & H Industries, Inc., Buyer acknowledges and represents that Buyer has read, fully understands and agrees to the Indemnification provisions set forth above.**

LIMITED WARRANTY

S & H Industries Inc. (SHI) warrants this product to be free from defects in materials or workmanship for two years after the date of original purchase.

If the product should become defective within that warranty period, SHI will repair or replace it (at SHI'S option) free of charge including return transportation to Buyer provided Buyer delivers it prepaid to S & H Industries Inc., 5200 Richmond Road, Bedford Hts., Ohio 44146.

This warranty does not include damage resulting from accident, abuse or misuse of the product. Nor does it apply to parts subject to abrasive wear, i.e., nozzles, air jets, seal blocks, valves, hose connections and hoses.

Implied warranties including those of merchantability and fitness for a particular purpose are excluded to the extent permitted by law, and any and all implied warranties are excluded. This is the exclusive remedy and liability for consequential damages under any and all warranties are excluded to the extent exclusion is permitted by law.